

V-Lock Block

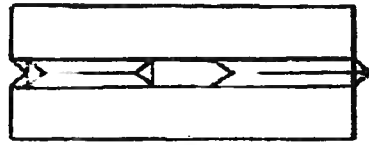

TOP VIEW



FRONT VIEW

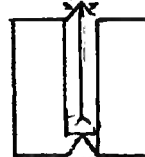
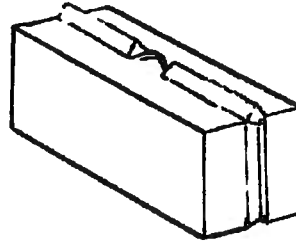

END VIEW

PLAN VIEW

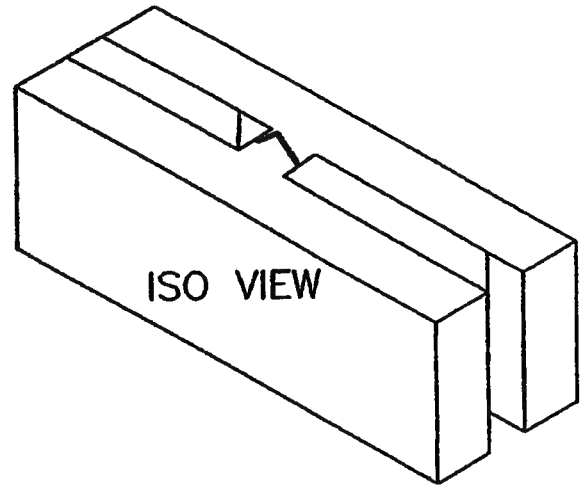
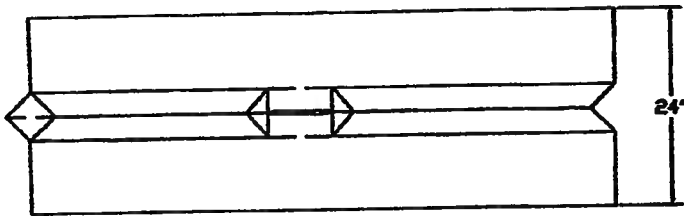

ISO VIEW

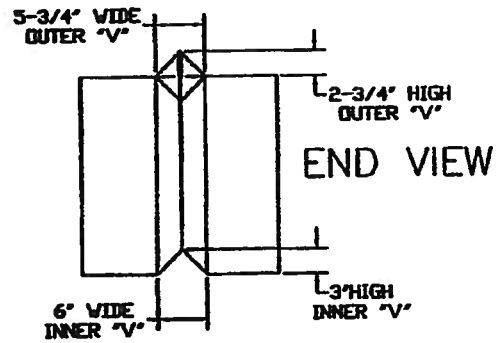
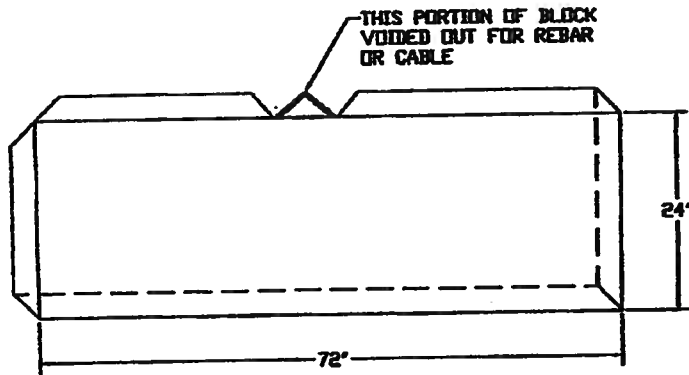

VOLUME = 24 CU FT
BLOCK WEIGHT = 3,600#